



iLogic^{700W}MS PLUS

MODEL: ILOGIC MS PLUS

WATTS 700W

VOLTAGE: 200 - 480V

SKU IL-L700MS-HV

TECHNICAL SPECS

Rated Voltage	200 - 480V
Power Consump	700W ± 5%
Power Supply	Sosen LED Drivers
ePAR - PPF	2298 µmol/s
ePAR Efficacy - Efficacy	3.04 µmol/J
LED Spectrum	Full Spectrum + UV + IR
Min Power Factor - Power Factor	>0.9
THD	<10%
Crest Factor	<10%
BTU	2300
Frequency	60Hz
Dimming	0 - 100% dimming via RS485
Ambient Temperature - Working	0°C - 35°C / 32° - 95°F
Relative Humidity	<90%
Color Temperature	4000K
Color Rendering Index	85
Emitting Cooling	Aluminum heatsink
Light Distribution - Beam Angle	120 Degree
Waterproof Rating	IP65
LED Lifespan	50000 hours
Daisy Chain	Unlimited with Plus Repeater
Light Source	Samsung LM281B+ Pro * 2184pcs Honglitrionic SMD3535 660nm * 168pcs Honglitrionic SMD3030 (UV) * 144pcs Honglitrionic SMD2835 (FR) * 144pcs

PHYSICAL SPECIFICATIONS

Height	75 mm/2.9"
Weight - N.W./G.W.	13.5kg / 15.5kg 29.7lbs / 34.1lbs
Package Size	1130*575*85mm / 44.5* 22.6*3.3"

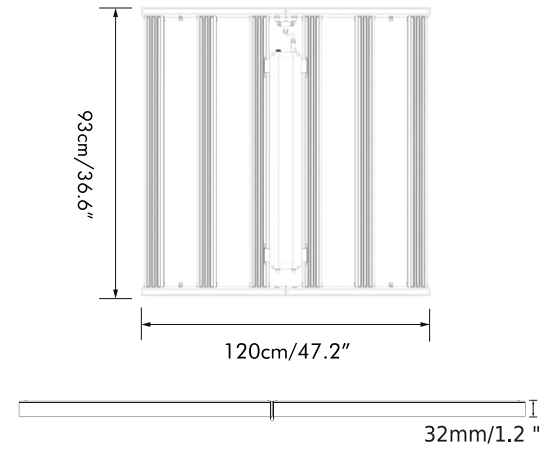

VOLTAGE AND AMPERAGE

Voltage	240V	277V	347V	480V
Amperage	2.91A	2.52A	2.01A	1.45A

SPECTRUM

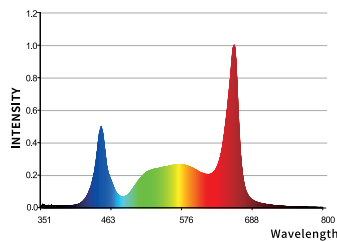

Full Spectrum
100% ON.

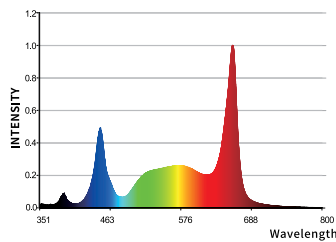

Full Spectrum
ON 100% + UV 100%
ON.

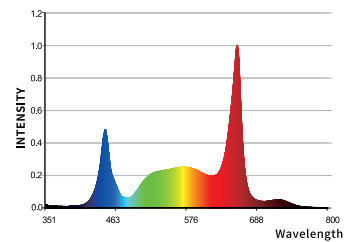

Full Spectrum
100% ON + FR 100%
ON.

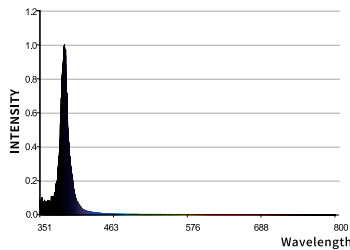

UV 100% ON.

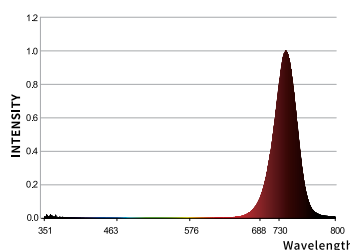

FR 100% ON.

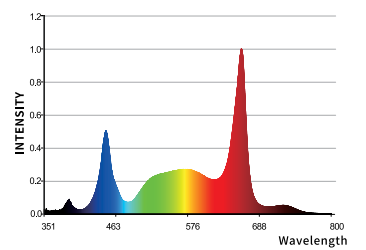

Full Spectrum
100% ON + UV 100%
ON + FR 100% ON.



This commercial fixture requires a separately purchased Plus Controller to operate.

5 YEAR
WARRANTY



www.iluminarlighting.com | 1-877-540-5588 | sales@iluminarlighting.com
© Copyright 2026 ILUMINAR Lighting. Subject to change without notice.